

# DUAL POWER AMPLIFIER

# DA-1250D

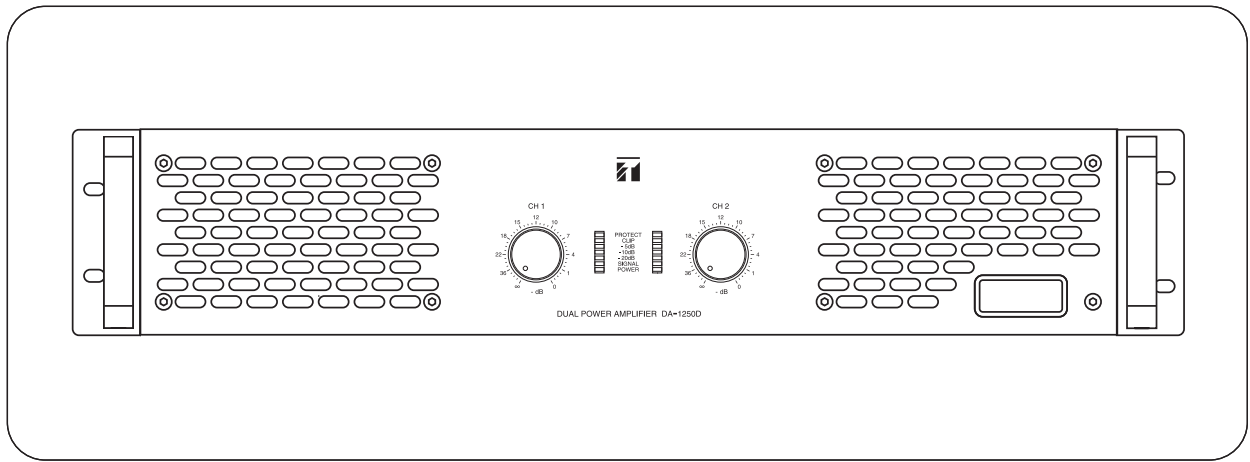

## TABLE OF CONTENTS

1. IMPORTANT SAFETY INSTRUCTIONS .....	2
2. SAFETY PRECAUTIONS .....	2
3. GENERAL DESCRIPTION .....	5
4. NOMENCLATURE AND FUNCTIONS .....	5
5. CONNECTIONS .....	7
6. SYSTEM CONNECTION CASES .....	8
7. THERMAL DISSIPATION .....	9
8. POWER LEVEL ADJUSTMENT .....	10
9. TROUBLESHOOTING .....	11
10. SPECIFICATIONS .....	12
11. DIMENSIONAL DIAGRAM .....	12

Thank you for purchasing TOA's Dual Power Amplifier.  
Please carefully follow the instructions in this manual to ensure long, trouble-free use of your equipment.

## 1. IMPORTANT SAFETY INSTRUCTIONS

- Read these instructions.
- Keep these instructions.
- Heed all warnings.
- Follow all instructions.
- Do not use this apparatus near water.
- Clean only with dry cloth.
- Do not block any ventilation openings. Install in accordance with the manufacturer's instructions.
- Do not install near any heat sources such as radiators, heat registers, stoves, or other apparatus (including amplifiers) that produce heat.
- Do not defeat the safety purpose of the polarized or grounding-type plug. A grounding type plug has two blades and a third grounding prong. If the provided plug does not fit into your outlet, consult an electrician for replacement of the obsolete outlet.
- Protect the power cord from being walked on or pinched particularly at plugs, convenience receptacles, and the point where they exit from the apparatus.
- Only use attachments/accessories specified by the manufacturer.
- Use only with the cart, stand, tripod, bracket, or table specified by the manufacturer, or sold with the apparatus. When a cart is used, use caution when moving the cart/apparatus combination to avoid injury from tip-over.



- Unplug this apparatus during lightning storms or when unused for long periods of time.
- Refer all servicing to qualified service personnel. Servicing is required when the apparatus has been damaged in any way, such as power-supply cord or plug is damaged, liquid has been spilled or objects have fallen into the apparatus, the apparatus has been exposed to rain or moisture, does not operate normally, or has been dropped.

## 2. SAFETY PRECAUTIONS

- Before installation or use, be sure to carefully read all the instructions in this section for correct and safe operation.
  - Be sure to follow all the precautionary instructions in this section, which contain important warnings and/or cautions regarding safety.
- After reading, keep this manual handy for future reference.

### Safety Symbol and Message Conventions

Safety symbols and messages described below are used in this manual to prevent bodily injury and property damage which could result from mishandling. Before operating your product, read this manual first and understand the safety symbols and messages so you are thoroughly aware of the potential safety hazards.



The exclamation point within an equilateral triangle is intended to alert the user to the presence of important operation and maintenance (servicing) instruction in the literature accompanying the appliance.



### **WARNING**

Indicates a potentially hazardous situation which, if mishandled, could result in death or serious personal injury.

### When Installing the Unit

- Do not expose the unit to rain or an environment where it may be splashed by water or other liquids, as doing so may result in fire or electric shock.
- Use the unit only with the voltage specified on the unit. Using a voltage higher than that which is specified may result in fire or electric shock.
- Do not cut, kink, otherwise damage nor modify the power supply cord. In addition, avoid using the power cord in close proximity to heaters, and never place heavy objects -- including the unit itself -- on the power cord, as doing so may result in fire or electric shock.
- Avoid installing or mounting the unit in unstable locations, such as on a rickety table or a slanted surface. Doing so may result in the unit falling down and causing personal injury and/or property damage.
- External wiring connected to the terminals marked with ⚡ requires installation by an instructed person.
- The apparatus shall be connected to a mains socket outlet with a protective earthing connection.
- The socket-outlet shall be installed near the equipment and the plug (disconnecting device) shall be easily accessible.

### When the Unit is in Use

- Should the following irregularity be found during use, immediately switch off the power, disconnect the powersupply plug from the AC outlet and contact your nearest TOA dealer. Make no further attempt to operate the unit in this condition as this may cause fire or electric shock.
  - If you detect smoke or a strange smell coming from the unit
  - If water or any metallic object gets into the unit
  - If the unit falls, or the unit case breaks
  - If the power supply cord is damaged (exposure of the core, disconnection, etc.)
  - If it is malfunctioning (no tone sounds.)
- To prevent a fire or electric shock, never open or remove the unit case as there are high voltage components inside the unit. Refer all servicing to your nearest TOA dealer.
- Do not place cups, bowls, or other containers of liquid or metallic objects on top of the unit. If they accidentally spill into the unit, this may cause a fire or electric shock.
- Do not insert nor drop metallic objects or flammable materials in the ventilation slots of the unit's cover, as this may result in fire or electric shock.



## CAUTION

Indicates a potentially hazardous situation which, if mishandled, could result in moderate or minor personal injury, and/or property damage.

### When Installing the Unit

- Never plug in or remove the power supply plug with wet hands, as doing so may cause electric shock.
- When unplugging the power supply cord, be sure to grasp the power supply plug; never pull on the cord itself. Operating the unit with a damaged power supply cord may cause a fire or electric shock.
- When moving the unit, be sure to remove its power supply cord from the wall outlet. Moving the unit with the power cord connected to the outlet may cause damage to the power cord, resulting in fire or electric shock. When removing the power cord, be sure to hold its plug to pull.

- Do not block the ventilation slots in the unit's cover. Doing so may cause heat to build up inside the unit and result in fire.
- Avoid installing the unit in humid or dusty locations, in locations exposed to the direct sunlight, near the heaters, or in locations generating sooty smoke or steam as doing otherwise may result in fire or electric shock.
- To avoid electric shocks, be sure to unplug the unit's power supply cord when connecting speakers.
- Be sure to follow the instructions below when rack-mounting the unit. Failure to do so may cause a fire or personal injury.
  - Install the equipment rack on a stable, hard floor. Fix it with anchor bolts or take other arrangements to prevent it from falling down.
  - When connecting the unit's power cord to an AC outlet, use the AC outlet with current capacity allowable to the unit.
  - No rack-mounting screws are supplied with the unit. Separately prepare the appropriate screws for the rack.

### When the Unit is in Use

- Do not place heavy objects on the unit as this may cause it to fall or break which may result in personal injury and/or property damage. In addition, the object itself may fall off and cause injury and/or damage.
- Make sure that the volume control is set to minimum position before power is switched on. Loud noise produced at high volume when power is switched on can impair hearing.
- Do not operate the unit for an extended period of time with the sound distorting. This is an indication of a malfunction, which in turn can cause heat to generate and result in a fire.
- If dust accumulates on the power supply plug or in the wall AC outlet, a fire may result. Clean it periodically. In addition, insert the plug in the wall outlet securely.
- Switch off the power, and unplug the power supply plug from the AC outlet for safety purposes when cleaning or leaving the unit unused for 10 days or more. Doing otherwise may cause a fire or electric shock.



The lightning flash with arrowhead symbol, within an equilateral triangle, is intended to alert the user to the presence of uninsulated "dangerous voltage" within the product's enclosure that may be of sufficient magnitude to constitute a risk of electric shock to persons.

- **Clean the unit regularly**

Contact your TOA dealer as to the cleaning. If dust is allowed to accumulate in the unit over a long period of time, a fire or damage to the unit may result.

- **Clean the power supply plug**

If dust accumulates on the power supply plug or in the wall AC outlet, a fire may result. Clean it periodically. In addition, insert the plug in the wall outlet securely.

- **During maintenance or leaving the unit unused**

Turn off this unit's power switch, and unplug the power supply plug from the AC outlet for safety purposes when cleaning or leaving the unit unused for 10 days or more. Doing otherwise may cause a fire or electric shock.

### 3. GENERAL DESCRIPTION

The DA-1250D is 2-Channel Digital Power Amplifier featuring lightweight, compact and high power output.

- It delivers 1250W x 2 channels (4Ω output).
- It can be mounted on an EIA standard equipment rack (2 unit size).

### 4. NOMENCLATURE AND FUNCTIONS

[Front]

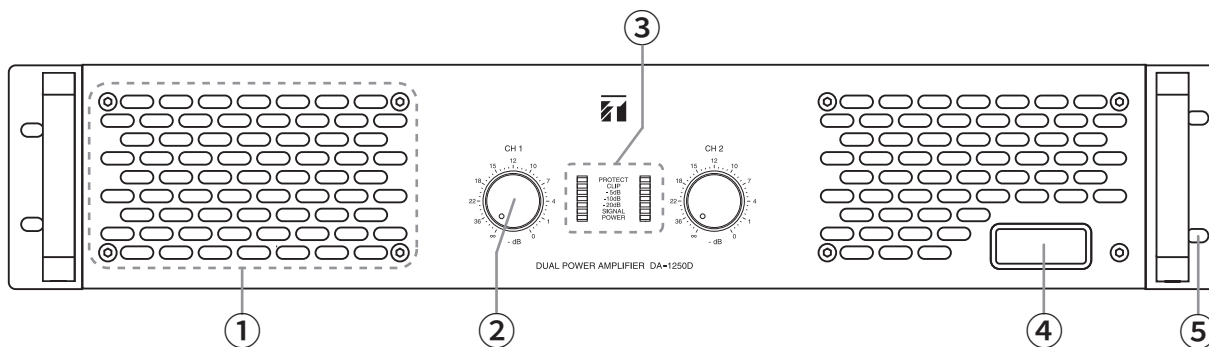

#### 1. Suction hole

#### 2. Input volume control

Turn the knob clockwise to increase the volume and counterclockwise to decrease it.

Stereo/Parallel Mode : volumes of CH1 and CH2 control independently .

Bridge Mode : CH1 knob controls both volumes, CH2 knob lose efficacy.

#### 3. LED indicator

PROTECT : Lights red when either protection circuit action.

CLIP : Lights red when compressor/limiter is protecting the amplifier from input overload.

-5dB : Lights green when output signal around -5dB than full power.

-10dB : Lights green when output signal around -10dB than full power.

-20dB : Lights green when output signal around -20dB than full power.

SIGNAL : Lights green when audio signals are output from the speaker output terminal.

POWER : Lights green when the Power switch (4) is switched on.

#### 4. Power switch

Power is switched on and off with each depression of this switch.

#### 5. Mounting hole

Can be mounted on an EIA standard equipment rack (2 unit size).

[Rear]

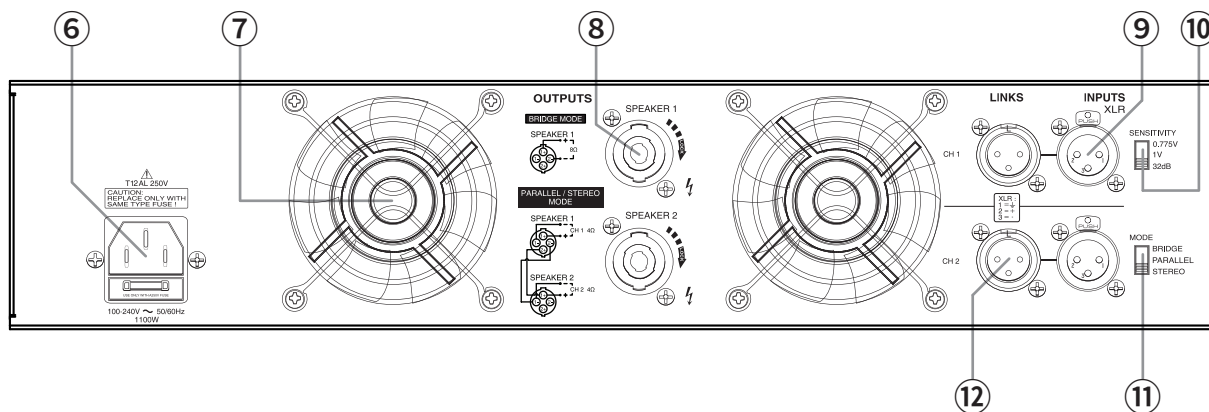

**6. Socket with fuse**

Connects to power source with AC power supply cord.  
 The Standard Voltage : AC 100 ~ 240V.  
 Dissipation Power : 1100W.  
 Power supply Cable size :  $\geq 1.5\text{mm}^2$ .  
 Fuse ratings : T12AL 250V.

**7. Fan**

**8. Speaker output terminal**

Speaker output, Speakon ( NL4 ) terminal.  
 Connects to speakers. Refer to p.7 and p.8.

**9. Signal input**

20k $\Omega$  (balanced) / 10k $\Omega$  (unbalanced), XLR-F connector.  
 Connects to Signal source.

**10. Sensitivity selector switch**

Selects the input sensitivity of input as follows: 0.775 / 1.0V / 32dB\*2.  
 Refer to p.8.

**11. Mode selector switch**

Selects the mode of input as follows: Bridge / Parallel / Stereo.  
 Refer to p.8.

**12. Signal output (LINK)**

XLR-M connector.  
 Connects to another one input terminal of the power amplifier.  
 Refer to p.7.

## 5. CONNECTIONS

### [Cable end treatment]

**NOTES:** The quality of your soldering is very important virtual welding or soldering errors, Would be likely to affect the normal use or even failure.

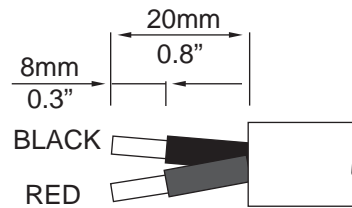

### [Inputs]

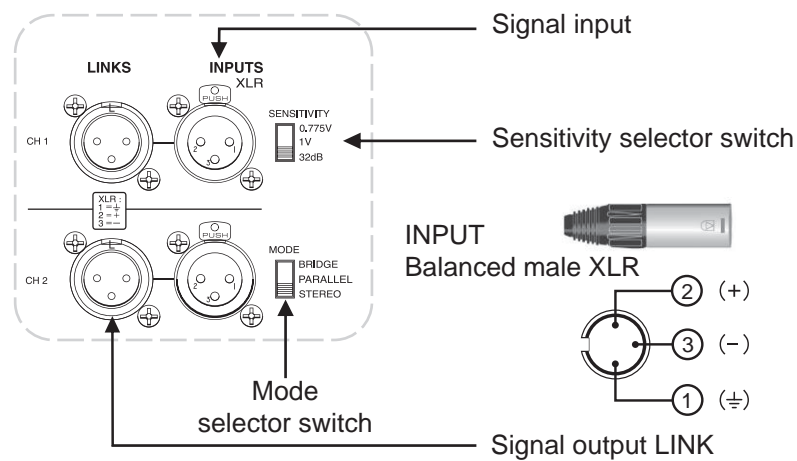

### [Outputs]

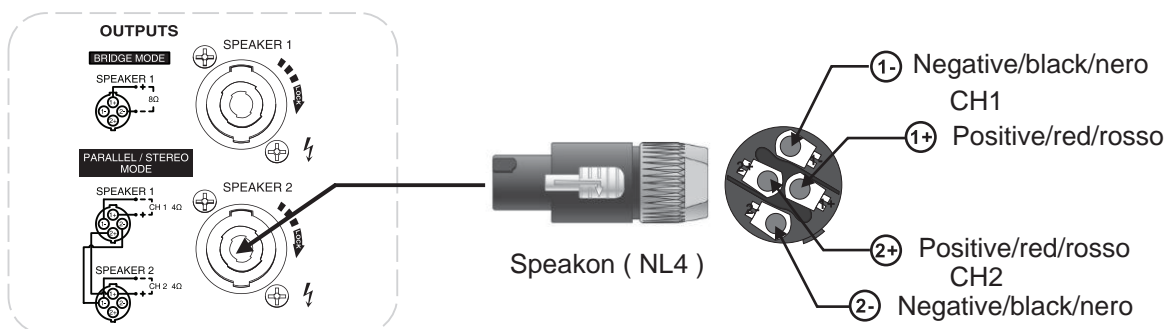

**NOTES:** The speaker connector can work from 4-16Ω in srereo or parallel model. It can work good from 8Ω to 16Ω in bridge mode.

# 6. SYSTEM CONNECTION CASES

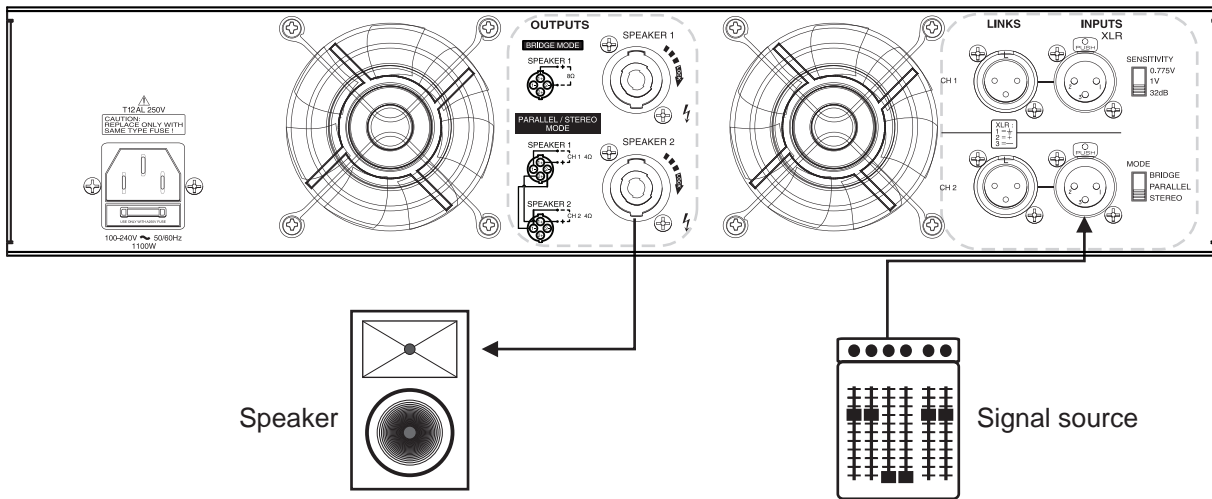

## Connection cases

### Bridge mode

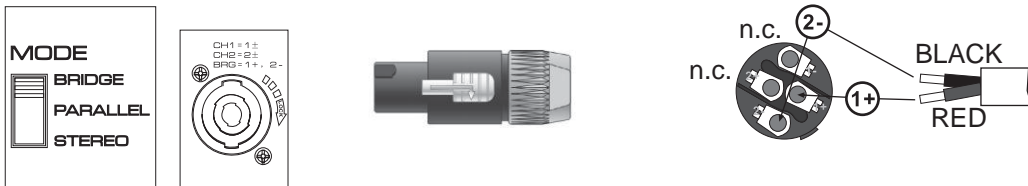

### Parallel mode

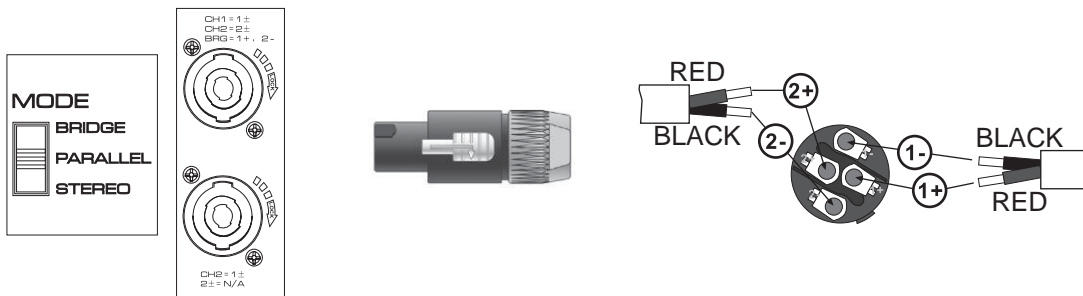

### Stereo mode

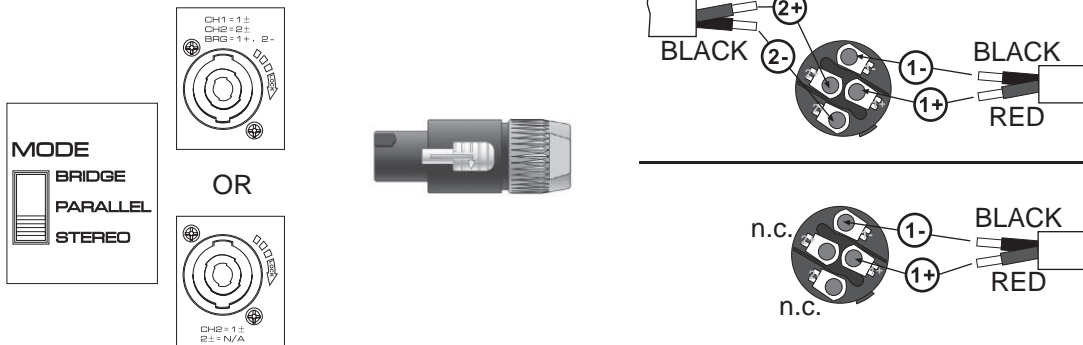



## 7. THERMAL DISSIPATION

### Stack installation

To ensure the cooling environment, please meet the following condition.

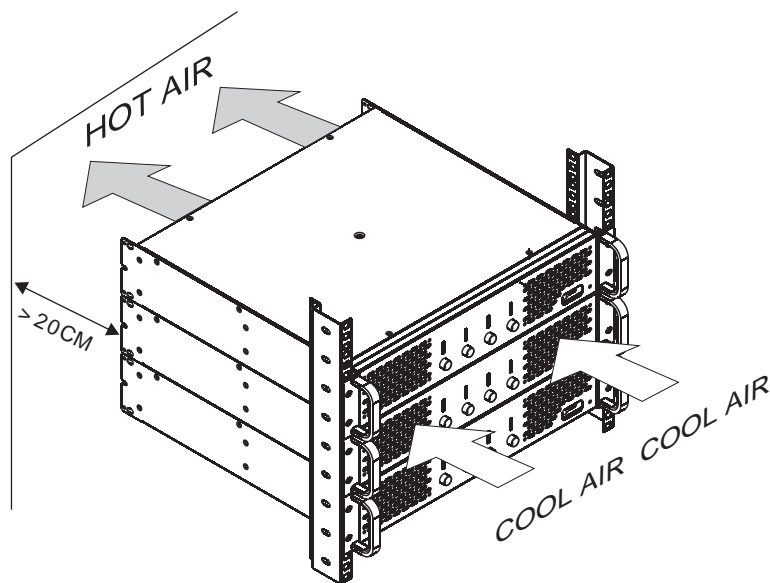

#### NOTES:

The ambient temperature should be lower than 35°C while running the amplifier.

#### NOTES:

In order to have a good heat dissipation condition for amplifier please clean the filter after you finish your install, because the dust in filter will stop the air vent, it's not good for the heat dissipation. And you should clean the filter net every month.



The first time cleaning of strainer mesh should be right after installation. Recommend to clean the strainer mesh quarterly. Please do not run the product without the dust filter, or it makes the service life of the product shorten.

**Such condition will be considered as no warranty.**

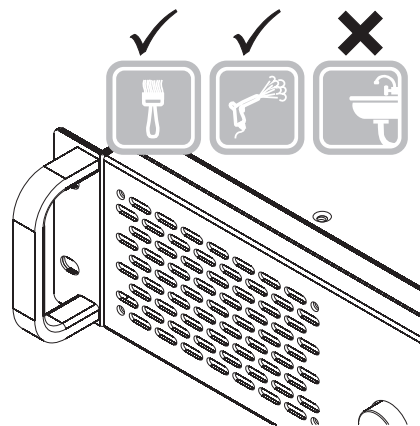

### To avoid heat protection

To prevent the hot air back to front airvent.

Install exhaust blower  
take the hot air away.

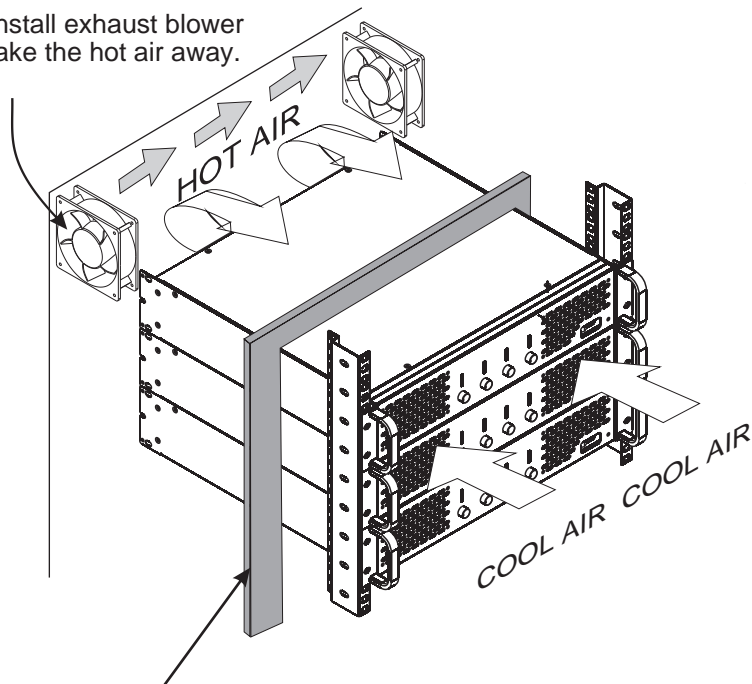

**NOTES:** Keep hot air will not flow back to the front air vent.

#### NOTES:

Try your best to keep the temperature under 35°C even in extreme condition.

#### NOTES:

If use in Non-horizontal stack, we suggest the rear exhaust outlet up or straight to the vents of the room.

# 8. POWER LEVEL ADJUSTMENT

## Procedure

Power on

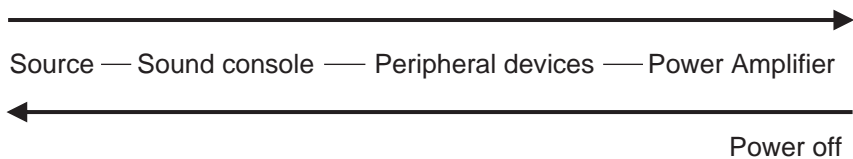

### NOTES:

For high power system, the Power-on order is very important, not in the order is likely to damage the equipment. Therefore we suggest that you use the sequence power device.

## Power Level Adjustment

Power amplifier should be in the condition of no load in the following adjustment process:

Process:

### NOTES:

This is a normal step to adjustment, for more professional adjustment you should have a professional person to do that.

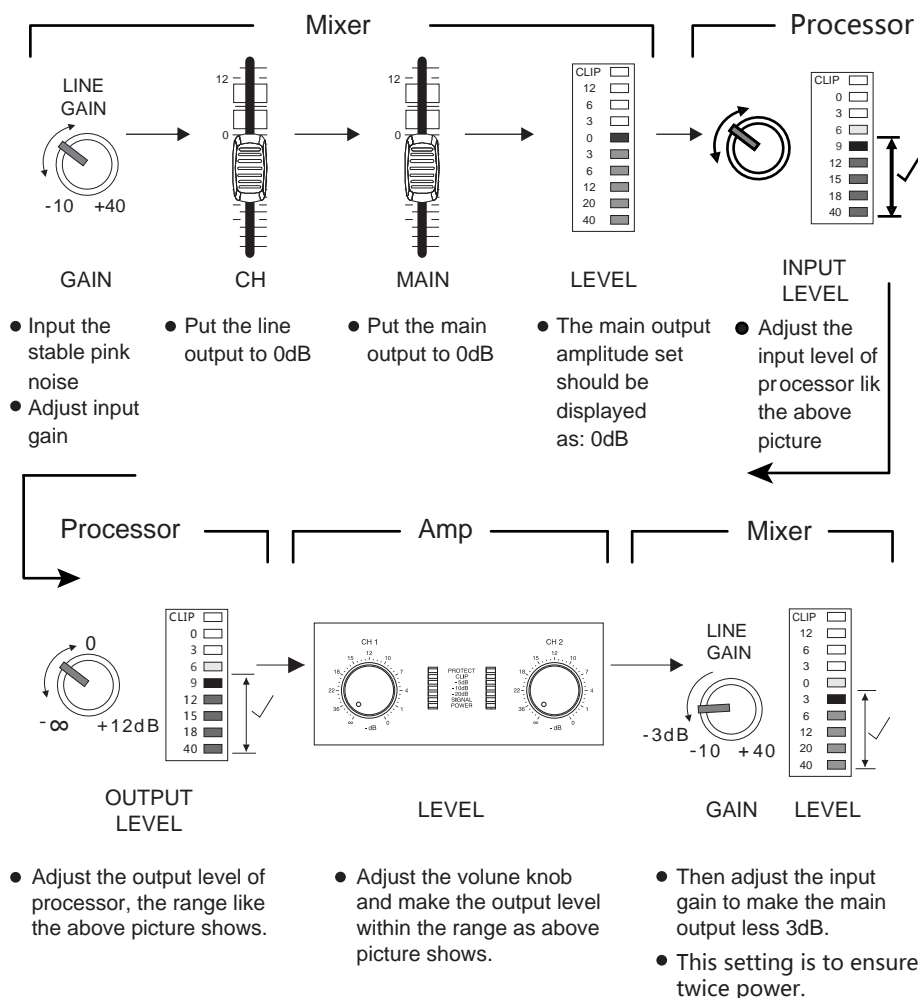

## Music Audition

Adjust the volume from very small to loud slowly, after you confirm the sound is normal then make it more louder. When the speaker output is close to its limit, the CLIP light will lights up and you should turn down your volume now, don't let the CLIP lights on long time, it means over load, may damage the system.

### NOTES:

This step should operated by professional person, if you don't know how to do, please be careful!

## 9. TROUBLESHOOTING

### After powered without any response

Measure the outlet with a multimeter to check if there is power available and when no multimeter, you can have a test pencil. If the power supply is normal and the amplifier still no response when powered then there is something wrong with the amplifier, need professional person to check it.

### No signal output

#### 1. Frist check if the signal input is right.

▲ Check the connect of XLR, if the 2 and 3 reverted or the ground is reliable. Different circuitry design will have different connect way of the XLR, please follow the 2+, 3- to soldering.

**It can not be judged by comparing with other amplifiers (including other amplifiers in the same factory).**

#### 2. The signal light don't lights up

If all the signal input is fine and the signal light don't lights up then may the amplifier has failure, you need to ask the professional person to check it.

#### 3. Signal input normal but no sound

The signal light will flash with the change of input volume, but no sound out, then you can check the connect of speakon if it is connect good and the wires are connect right (some times the problem of the wires connect, check its  $\pm 1$  and  $\pm 2$  connect), after the check above if still no sound out, please change a speaker cable and check again. Because some times also caused by the bad quality of the Speakon connector problem of the amplifier

▲ Through experiences, it may caused by the bad connection of some plugs and the socket.

### Output sound distortion

1. After check the signal and loudspeaker they are fine and still can hear distortion when small sound, then may the amplifier has failure, need professional person to check it.
2. Some frequency band has distortion  
First, check if the loudspeaker already overload, normally judge it in 95~105dB for higher SPL we don't comment here. Here we just think about the failure recovery of the amplifier. If in the middle have some rupture sound and more smaller volume more obvious, then it should be crossover distortion of the amplifier and this kind of distortion is easy to confuse with the failure of loudspeaker itself. If the amplifier have for problem then you should send back to the manufactur for repair.
3. Distortion is High SPL

If the sound is normal when small volume and then you need to check the limit SPL of the loudspeaker. You can listn it in suitable volume and if clip light works, then you need reduce the output. Both loudspeaker and amplifier have limit, you should use them in their limit if

in very high SPL they have distortion you should take care of them and reduce the output to the right position.

### The protection light blinks

#### When the PROTECT light works, the amplifier into the protection mode.

1. Maybe the temperature is too high or output short or near short and they are not failure they can recovery after you can use it normally. But over heat will take more time to recovery. Also when over heat happened you should cheak the fan and the temperature of the install environment, if does you should solve the problem then can use amplifier. If you think the speaker was short, you can with a multimeter to check if the resist is lower than 2 ohm or 1 ohm with DC (Please calibrate the multimeter to measure for accuracy because of the small esistance).
2. If the PROTECT awlays light up then it should be the problem of amplifier, you should send it back to professional person for repair.

### Hum in the system

1. Hum exists even when there is no signal  
Please keep the amplifier away from earth wire of power supply cables, just connect the fire wire and zero wire, no ground wire. If the hum is still existing, it can be judged that there are some problems in the amplifier. Please get in touch with professionals.
2. Hum exists when the system is completely connected  
This is caused by the different ground voltages in difference devices in the system, mainly happens when the power supply is under three-phase distribution condition, each device is connected to different phase. This is not caused by amplifier.

### Solution experiences, just for reference

- A. Combing the electricity, the power distribution box using the same one for all if possible.
- B. Make sure the grounding wire potential is zero and force the different grounding wire to the same level, if the grounding wire itself charged, indicates that the wire may be connected with the zero line. Please solve this problem.
- c. If unavailable above, then only to disconnect the ground wires of all devices, which helps to reduce the AC. But this is not meet the safe use of electricity, user s must know what will happen if to do in this way. We do not recommend the floating use.

### The amplifier is required maintenance in the condition below:

1. If the amplifier smokes or smells burning.
2. If the cabinet has severe indentation and deformation.
3. If the amplifier are dipped into the water.
4. If the internal components loosen.
5. If AC breaker skips out when current increases.

# 10. SPECIFICATIONS

Power Source	100 - 240V AC, 50/60 Hz
Amplification System	Class D
Power Consumption	1100W*1
Input	CH1-2 : 20kΩ ( balanced ) / 10kΩ ( unbalanced ), 0.775 / 1.0V / 32dB*2, XLR-F connector
Output	LINK CH1-2 : XLR-M connector SPEAKER 1-2 : 2 channels : 700Wx2 (8Ω)*3, 1250Wx2 (4Ω)*4 1 channels(BRIDGE) : 2500Wx1 (8Ω)*4 NL4 SPEAKON connector
Frequency Response	20Hz - 20kHz (+/-3dB)
Total Harmonic Distortion	≤0.15%
S/N Rate	≥100dB
LED Indicator	Protect (red)/ Clip (red)/ -5dB(green)/-10dB(green) / -20dB(green) / Signal(green) / Power(green)
Cooling	Air flow from front to rear
Operating Temperature	0°C~+35°C (32°F to 95°F)
Operating Humidity	80% RH or less (no condensation)
Finish	Case : plated steel sheet, black
Dimensions	483 (W) x 89 (H) x 305 (D) mm [19.02" x 3.5" x 12.01"]
Weight	6.1kg [13.45 lb]
Accessory	Power Cable ...1

\*1 2/3 rated, 8Ω/CH

\*2 0 dB = 1 V

\*3 The power is tested under the condition of 40ms burst 1kHz sin wave and 1% THD.

\*4 The power is tested under the condition of 20ms burst 1kHz sin wave and 1% THD.

**Note:** The design and specifications are subject to change without notice for improvement.

# 11. DIMENSIONAL DIAGRAM

Unit: mm [in]

